

EN



INSTALLATION GUIDELINES

INSTALLATION/SERVICING/MAINTENANCE/SAFETY ADVICE



DEL 

ABOVEGROUND COVER

MOOVE'O

CONTENTS

PLEASE READ THESE INSTRUCTIONS CAREFULLY AND KEEP THEM FOR FUTURE REFERENCE

Please read this manual carefully to help you understand all of the information and to ensure safe installation, use and servicing. We are not held liable for any damage arising due to a failure to respect the instructions set out in this manual.

DESCRIPTION.....	3
Components provided.....	3
INFORMATION.....	4
Prerequisites.....	4
Tools required for assembly.....	5
Packing list.....	5
Assembly.....	5
INSTALLATION.....	6
Opening the box.....	6
Installation.....	6
Settings.....	8
USE.....	9
Opening/closing the pool.....	9
Removable retaining strap.....	10
Electrical wiring.....	10
SERVICING/MAINTENANCE.....	11
Water level in pool.....	11
Water filtration and treatment.....	12
Servicing (customer's responsibility).....	12
Batteries.....	13
Maintenance.....	13
Wintering.....	14
Spare parts.....	15
Pièces détachées.....	15
Troubleshooting guide.....	15
SAFETY ADVICE.....	16
RECYCLING.....	18
Packaging.....	18
End of lifecycle.....	18
REGULATIONS.....	19
Warranty condition.....	19

DESCRIPTION

COMPONENTS PROVIDED





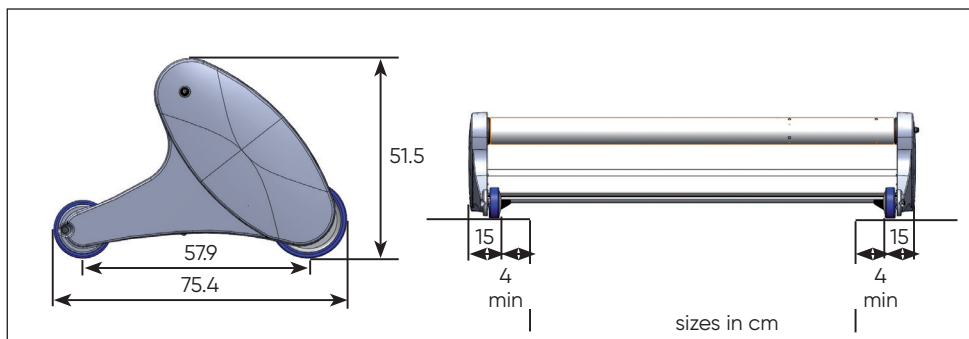

- 
- The motor (which complies with electrical standards) is located in the pole and can be accessed from inside the terminal.
 - Calibration of the "mechanical limit switches" that allow the apron to be stopped when it has been fully unrolled or when it is fully rolled onto the pole is carried out directly on the motor.

INFORMATION

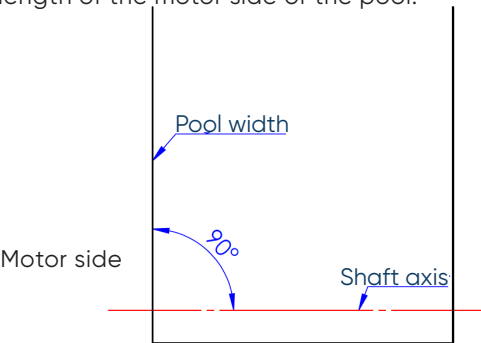

INFORMATION

PREREQUISITES

	<p>The water level must be maintained when the cover is installed.</p> 
	<p>For the deck to run smoothly, the mast axis must be positioned perpendicular to the length of the motor side of the pool.</p> 
	<p>The motor is located in the mast and is accessible from inside the housing. Power is supplied from an electrical box in the machine room. Limit switches are adjusted directly on the motor.</p>
	<p>Remember to wear safety equipment.</p>

-  **WE ADVISE YOU TO READ ALL THE INSTALLATION STEPS BEFORE FITTING TO AVOID UNNECESSARY HANDLING.**
- To date, covers with a removable form on a side staircase do not comply with standard NF P90-308.**
- Unless otherwise specified by the alarm manufacturer, immersion alarms are not compatible with .**

DESCRIPTION

TOOLS REQUIRED FOR ASSEMBLY



PACKING LIST

example – for a 5 x 10m pool with Ø3 m stairs

Moove'O + fastening devices: 1 0.80 x 0.70 x 5.50m package – 90kg

Slats: 5 5 x 0.25 x 0.20m packages – 190kg

Total weight: 280kg

ASSEMBLY



2 people



3 hours



- On infinity pools, DEL covers cannot be compatible unless the pool is equipped with a Vitalia INFINITY device to automatically lower the water level by at least 2cm when the pool cover is closed.
- Currently, DEL covers including an adjustable fitting to go over a ladder do not comply with standard NF P90-308
- Unless the alarm manufacturer indicates otherwise, immersion alarms are not compatible with DEL covers.

INSTALLATION

OPENING THE BOX

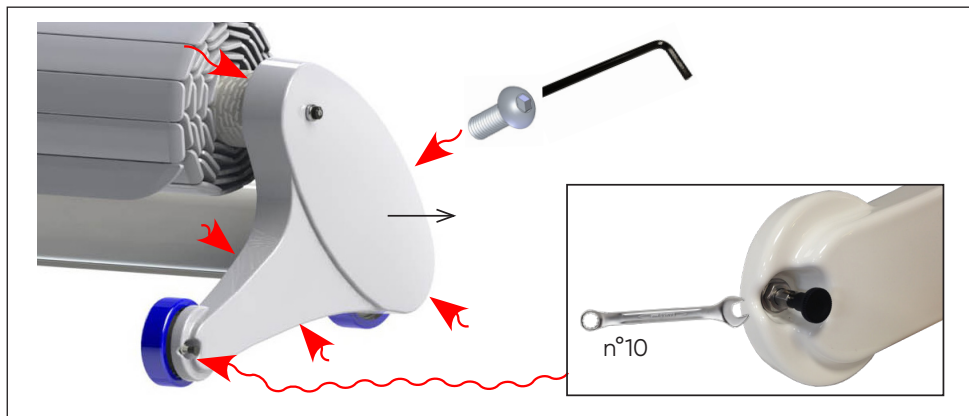

INSTALLATION

- ⚠ Be careful when moving the rewriter, its weight and its wheels could cause injury (crushing or trapping).

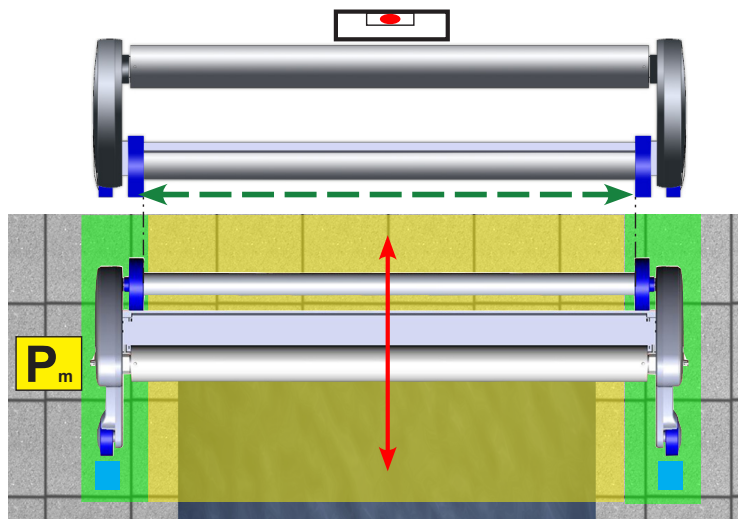

- ⬆️ movement occurs only in a straight line
- ↔️ the Moove'O is central to the pool

INSTALLATION

▶ THE POSITIONING OF THE REWINDER DEPENDS ON THE CORNER ANGLES OF THE POOL

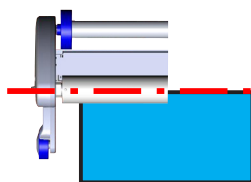

Right angles

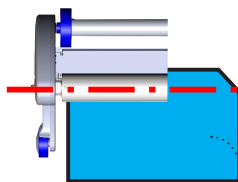

Rounded angles
or cut-off
corners

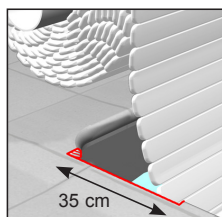

If required, angle grind the pool rim to help the apron pass over it more smoothly and to avoid issues with rubbing. For pools which are unusually shaped or have large shelves, a larger notch may be required.

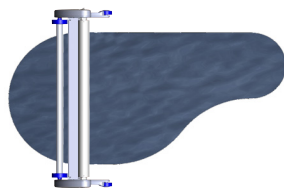

Manoeuvring position (key button):

In order to open and close the pool, position the Moove'O over the widest part of the pool.



These surfaces must not have any obstacles of more than 6.5cm in height. Be careful of the filtration block and the contour of the pool rim.



This surface needs to be smooth and hard-wearing enough to bear the weight of the Moove'O (maximum weight 340kg, moving over grass not recommended).



Stops for front wheels

Helps with identifying the exact position required for opening and closing the pool.

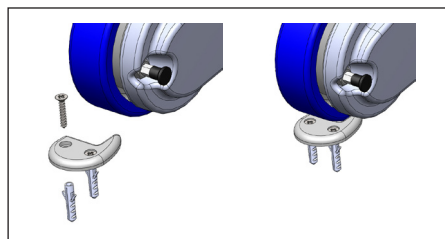
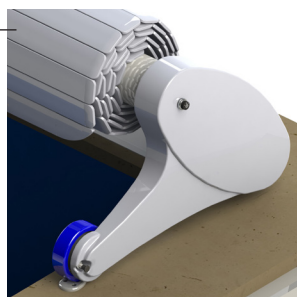

x1



x1



x4

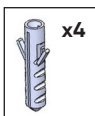

x4

INSTALLATION

- ❗ Any person carrying out work on the electrical parts must be qualified and wear PPE (personal protective equipment): gloves, goggles, mat, etc.
- ❗ Warning: use of the pool cover control buttons present in the housing (Wi-Key receiver) must only be carried out by a person who is absolutely certain that there is no risk and that no-one will enter the pool during the operation.

SETTINGS

▶ VERIFY

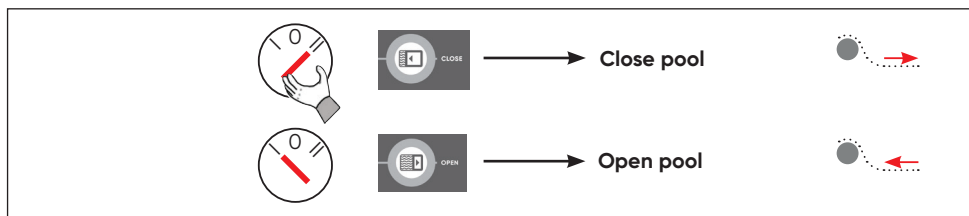

If the control logic is not respected, check the wiring of the installation.

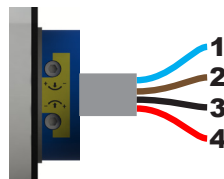

▶ PROGRAMMING THE LIMIT SWITCHES

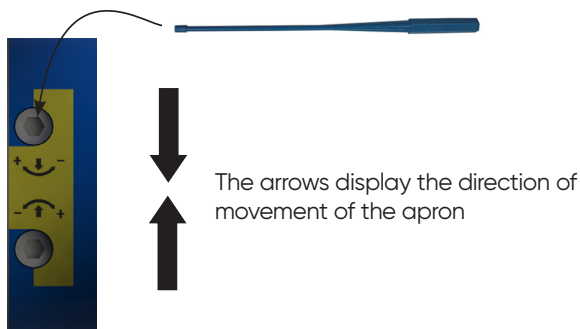
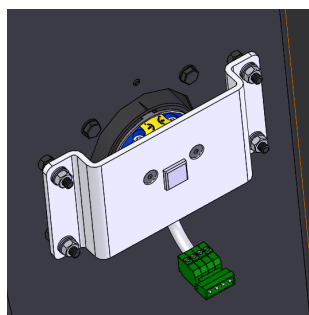

By turning in the + direction, you will increase the range of movement of the apron
By turning in the - direction, you will decrease the range of movement of the apron

USE

OPENING/CLOSING THE POOL



USING THE BRAKE

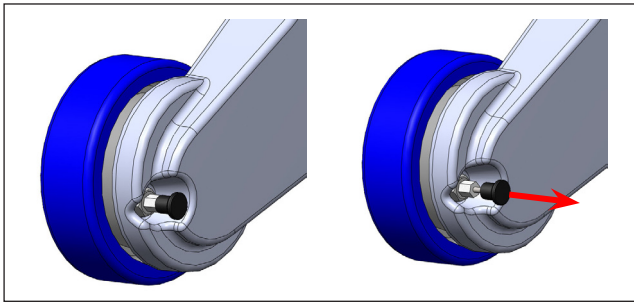

USE

REMOVABLE RETAINING STRAP

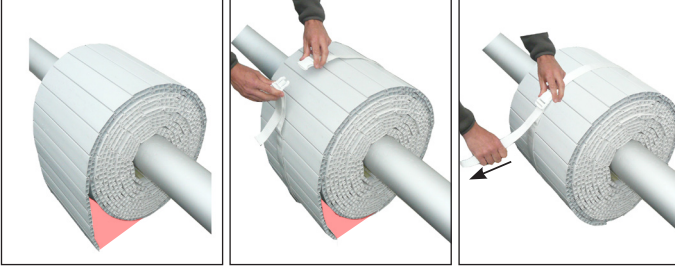

ELECTRICAL WIRING

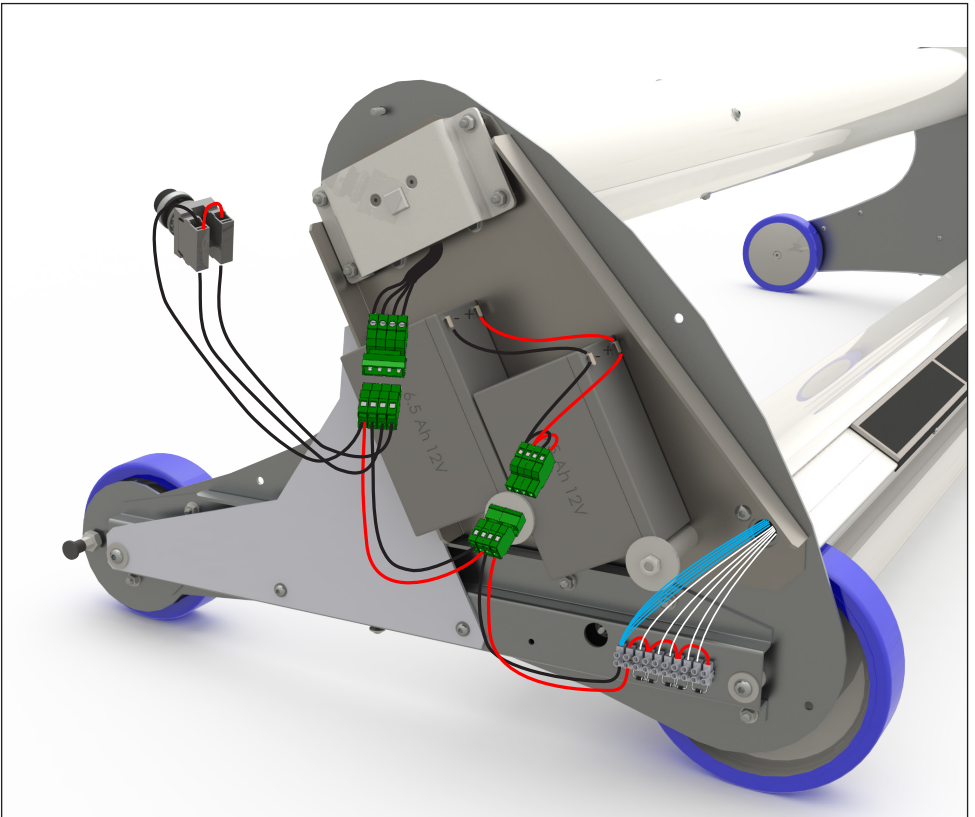

SERVICING/MAINTENANCE

Any person carrying out work on the electrical parts must be qualified and they must comply with the manufacturer's instructions in addition to the applicable standards and regulations.



During any intervention, the technician must wear PPE (personal protective equipment): gloves, goggles, mat, etc...

We recommend that the installation be disconnected from the power prior to any intervention taking place.

WATER LEVEL IN POOL

- In order to ensure maximum safety and correct operation of the rewinder, always check that the water level in the pool remains constant and complies with the manufacturer's requirements (for greater comfort, use an overflow and a water level regulator).
- A water level that is too high is due to the overflow being obstructed by leaves or other items.
- A water level that is too low means that there is a risk of blockage.
- In case of a recess or a handrail, the water level must be controlled by a level regulator.
- Complying with the recommended minimum and maximum water levels ensures proper operation and compliance with the requirements of standard NF P90-308.
- It is advisable to pay close attention to fluctuations in the water level. The most suitable method (to ensure both monitoring and the necessary corrections) is to combine an overflow system with automatic filling.
- The target water level is specific to each pool and depends on the overall configuration of the cover. It is necessary to combine the recommendations relating to the reel and its possible decking with those relating to safety locks and slats.
- The NF P90-308 standard requirements imply compliance with the recommendations throughout the year and therefore an active winterisation without lowering the water level is needed.
- The water level must be less than 25 cm below the deck; beyond this, please consult us.
- If a safety system is installed on the pool, refer to the recommended water level indicated for that system.

SERVICING/MAINTENANCE

WATER FILTRATION AND TREATMENT

- Programme filtration to take place at a time when the sun is shining on the pool and ensure that it is set to work all the time when the water reaches 28°C.
- In order to ensure that your installation will last, the water in the pool must be correctly treated in compliance with the applicable standards and recommendations (NF EN 16713-3).
- The pH, hardness and alkali levels of the water must be checked and adjusted as often as is necessary (although you will need to ensure that you don't correct these three parameters independently of each other but do so using the Taylor table and provide the water with balance with regard to the three parameters analysed).

SERVICING (CUSTOMER'S RESPONSIBILITY)

- Carry out a deep clean of the apron twice per year (the first time in the year it is used and prior to overwintering). This is even more important if the water in the pool is hard. To do so, use a pressure washer with hot water and a descaling cleaning product (Décalcit super).
- Also ensure that you regularly clean the fastening devices especially the piton to avoid it getting stuck. We recommend annual greasing of the piton to ensure that the system works as well as possible.
- It is best to inspect the entire system if the cover is forced to bear unexpected weight at any time (if anything falls on it).
- Carry out an annual check of the straps.
- For optimal solar sensor performance, clean it regularly using a window cleaning product.

SERVICING/MAINTENANCE

BATTERIES

At the first sign of the batteries losing power, recharge them.

NEVER LET THE BATTERIES LOSE THEIR CHARGE COMPLETELY.

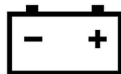

Always disconnect the solar collectors beforehand then disconnect the batteries.

Connect the batteries to the charger (check the polarity). Plug the charger in. It will switch on automatically to the correct voltage and the charging process will begin. The red LED shows that charging is underway. When the charge is complete, the red LED will be switched off and the batteries are then powered by a maintenance charge (see charger instructions).

Precaution: Keep your charger in a dry place. Do not recharge the batteries close to the pool, but instead do so in a dry place.

Minimum recharging time: 48 hrs

MAINTENANCE

- All interventions must be carried out by a professional, who will contact the manufacturer if necessary.
- All spare parts must come from the manufacturer or comply with applicable standards.
- Inspect the cover thoroughly.
- It is necessary to check at the start of every season and if any accident has occurred (if anything has fallen onto the cover, if hail has struck the cover, if the cover has had to bear any abnormal weight etc...) check that none of the slats has sustained any visible damage that may affect the safety of the cover (cracked slats, holes, deformations, etc...). Make sure that you change the slats or the entire apron if required.
- In summer or in winter: do not place an opaque sheet over the cover: this may damage the slats due to high temperature.
- Check the state of the straps (seams) and in particular the wear on the anti-abrasion sleeve. If the latter is no longer fulfilling its role of protecting the strap against abrasions from the pool rim, then replace it

SERVICING/MAINTENANCE

WINTERING

- Position the cover in the closed position and keep the water level constant in accordance with the manufacturer's recommendations.
- Close the cover in the safety position.
- Leave the batteries connected to the reel and do not cover the solar panel.
- We recommend installing an Ivernéa winter cover or an Ivernéa Plus protective cover to protect the cover from UV rays and dirt.

SERVICING/MAINTENANCE

SPARE PARTS

Online catalogue :



<https://www.my-cfgroup.fr/fr/pièces-detachées>

TROUBLESHOOTING GUIDE

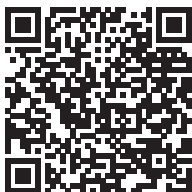

<https://view.publitas.com/cfgroup/quick-troubleshooting-moo-veo-cover/>

SAFETY ADVICE

We recommend that you carefully read the recommendations below.

WARNING

- **Swimming pools can represent a serious danger for your children. Drowning can happen very quickly.**
Children who are close to a swimming pool need to be watched constantly and actively, even if they know how to swim.
- **The physical presence of an adult is absolutely essential whenever the pool is open.**



- Learn lifesaving skills.
- Memorise the telephone numbers for the emergency services and ensure that they are displayed close to the pool.



SAFETY ADVICE

- This cover is by no means a replacement for common sense or individual responsibility. Its aim is not to replace the vigilance of parents and/or responsible adults, who remain the essential factor in ensuring the protection of young children.
- **WARNING:** safety is only guaranteed when the cover is closed, locked and correctly installed in compliance with the manufacturer's instructions.
- The cover must systematically be closed if you are absent from home, even for a very short period.
- Check that no people and no foreign objects are in the pool before and during opening and closing operations.
- Make sure that you place all of the tools required for moving the pool cover out of the reach of children (e.g. the key).
- The operation of the mechanism must only be carried out by a responsible adult.
- Climbing, walking or jumping on a pool cover is strictly forbidden.
- Take all necessary measures to prevent access to the pool for young children until the cover is repaired or when a malfunction is observed that prevents closing or in case of temporary unavailability of the equipment or the pool.
- Respect the water levels designated by the manufacturer.

A child can drown in less than 3 minutes, no type of protection can ever replace the watchful eye and vigilance of a responsible adult.

RECYCLING

PACKAGING



Dispose of the packaging in line with current rules and regulations.

END OF LIFECYCLE



- Do not put your scrapped equipment or used batteries in with unsorted household waste.
- You are responsible for disposing of all of your waste, in particular electrical and electronic equipment by taking it to a collection point where recycling and valorisation are carried out.
- Certain products potentially contain substances that are dangerous for the environment, and you need to ensure that these are eliminated or neutralised.
- Make sure that you are aware of all existing recovery and collection systems.



discard the manual in line with the current regulations.

REGULATIONS

WARRANTY CONDITION

log on to www.del-piscine.fr to consult all our guarantees.



<https://www.del-piscine.fr/rechercher-une-garantie>

DEL SAS
ZA LA BASSE CROIX ROUGE
35530 BRÉCÉ - FRANCE

☎ +33 (0)9 70 72 5000 / INFO.FR@CF.GROUP

STAMP

A brand by CF group

a brand by

